

# Ring Blower

Side Channel Blower

# 環形鼓風機



IE3

Premium Efficiency



## CHUAN FAN



台灣產品新型專利第 205327 • 222602 • 118075 • 342421 • 398031 號

**MotorWorld +84888088884**

# 環形鼓風機 Ring Blower (Side Channel Blower)



直落式繞線機  
Vertical stator coil auto  
winding machine



IE3全自動馬達繞線/  
入線/整形機與生產線  
IE3 Automatic motor Stator winding/  
Wedge Inserter/ Coil Forming  
Machinery and Production Line

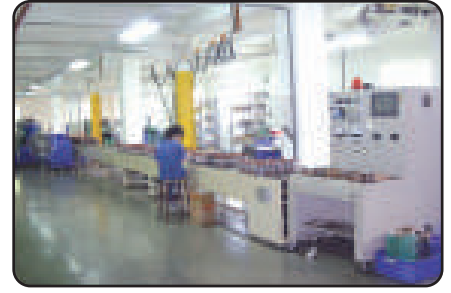

馬達定子檢驗機  
Stator Test Machine



**RB-200**



**RB-400**



**RB-750**



**RB-022**



自動凡立水處理機  
Vanish Machine

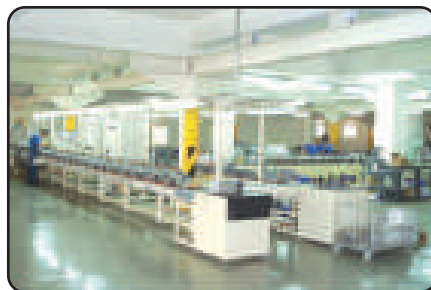

裝配線與自動測試  
Assemble Line

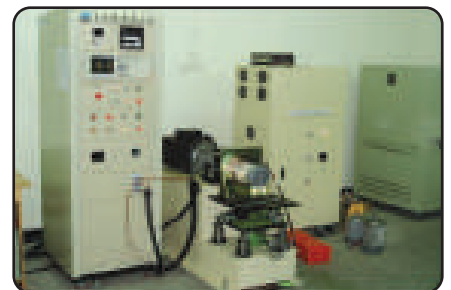

馬達動力測試  
Motor Test Systems

# 環形鼓風機 **Ring Blower** (Side Channel Blower)



低壓鑄造機  
Low Pressure Casting Machines



重力壓鑄機  
Gravity Die Casting Machines



壓鑄機  
Die Casting Machines



**RB-033**



**RB-055**



**RB-077**



**RB-1525**



加工區  
CNC Vertical Lache



加工區  
Machining Centers



裝配  
Assemble



## 環形鼓風機 Ring Blower (Side Channel Blower)

### 特點：

#### 小型 ● 重量輕 ● 高風壓

前傾式葉片設計，體積小、質量輕且較有高壓力之產生。

#### 低噪音

新設計，能消除切風時產生之高頻及特殊之消音材質，大幅降低噪音比。

#### 低震動

葉片均經過電腦平衡校正與高精密的機械加工，使震動降到最低。

### Features:

#### Low noise and vibration

Dynamic balancing minimizes vibration.

#### Dust-proofed shaft seal

Protects bearings from contaminated air stream and possible foreign particle damage.

#### High reliability

Directly connected motor shaft-impeller provides reliable, long term performance. No gears, belts, motor brushes or sliding blades to require periodic maintenance.

#### Space-efficient design

Unique design results in substantial airflows at moderate pressures in minimum space and weight.

#### Versatility

Easily throttled and changed from pressure to suction operation. May be mounted in a variety of fashiond.

#### Stable airflow

Centrifugal compressor design delivers smooth, stable airflow with no pulsations.

#### High-pressure airflow

Produces continuous high-pressure airflow. The Ring Blower is ideally suited to many industrial applications.

編號 number	零件名稱 Description
01	機殼 Housing
02	機蓋 Cover
03	葉輪 Impeller
04	底座 Base
04-1	消音棉 Sound absorption material
04-2	沖孔網 Perforated metal mesh
05	法蘭 Flange
K1	滑鍵 Key
P1	密合墊 Gasket
S1	油封 Oil seal
M1	馬達 Motor
W1	套筒 Sleeve
W2	防鬆墊片 Captive ring
W3	防鬆墊片 Captive ring

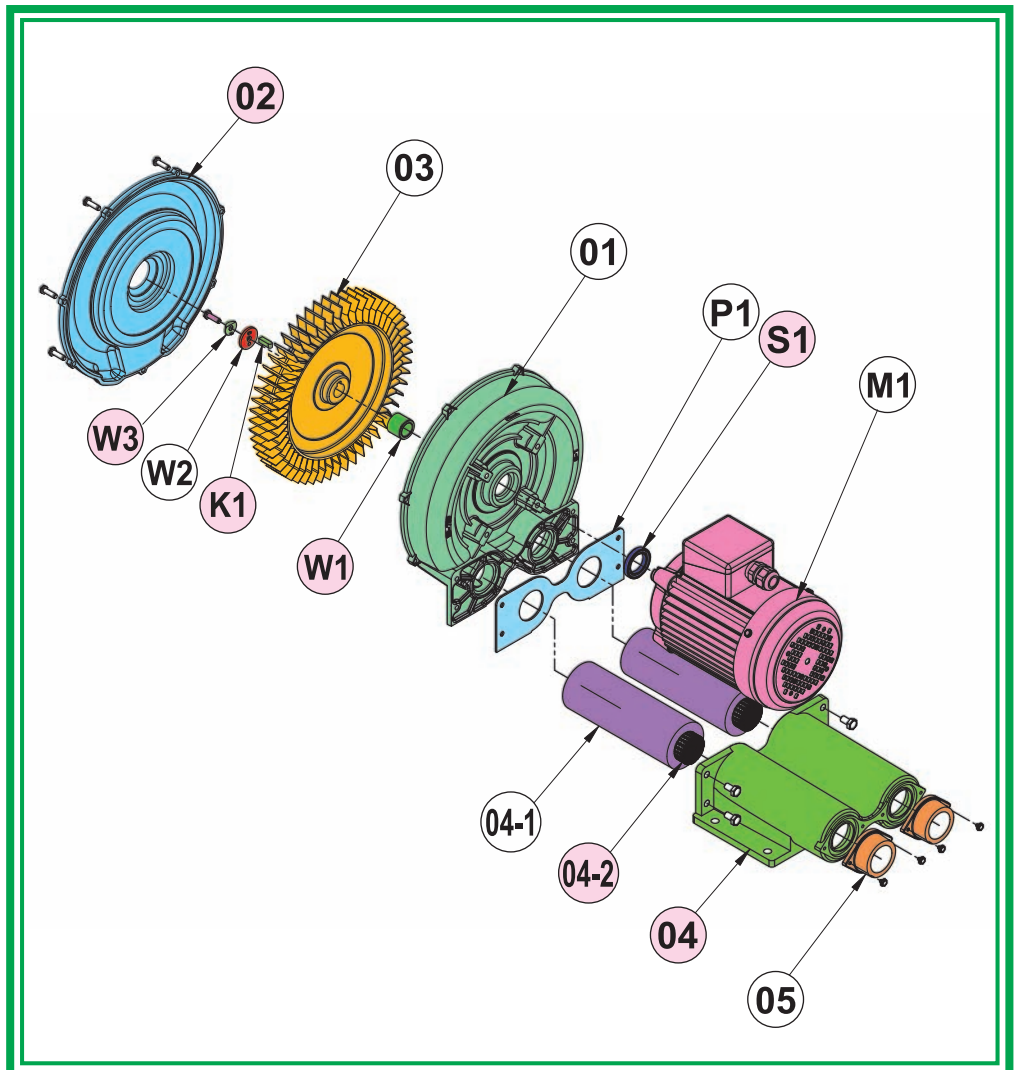



# 環形鼓風機 Ring Blower (Side Channel Blower)

## 用途：

- 粉粒體輸送
- 紡織纖維集塵
- 裁紙（布）機氣墊
- 污水處理瀑氣
- 窯業礦業空氣
- 重油噴燃
- 造紙紙漿脫水
- 無梭織布機專用
- 玻璃工業及冰廠空氣泵
- 遂道工程壓送空氣
- 水產養殖氧氣供給

## Applications:

- Grain elevators
- Textile fiber collections
- Paper industry
- Sewage treatments
- Cement manufacturing
- Diesel burning
- Pulp industry
- Glass manufacturing
- Ice manufacturing
- Tunnel ventilation
- Fishery industry

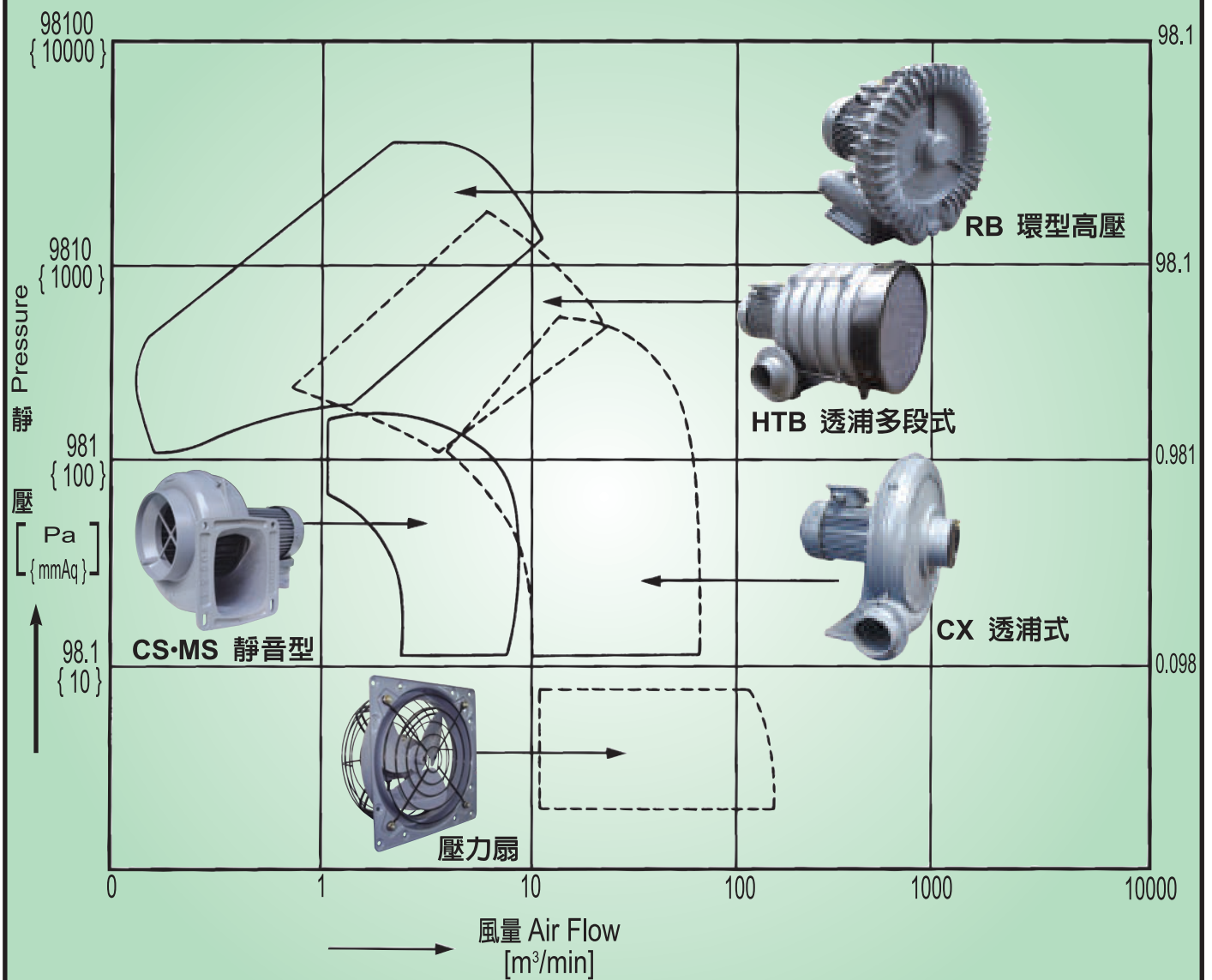

## 性能比較圖



請選擇最適用的機型

送風 ● 吸塵 ● 排氣 ● 冷卻 ● 輸送 ● 氣墊

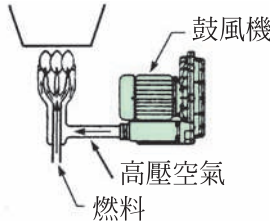
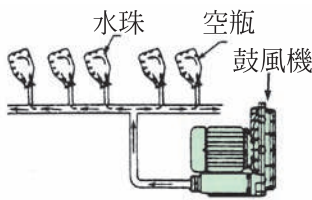
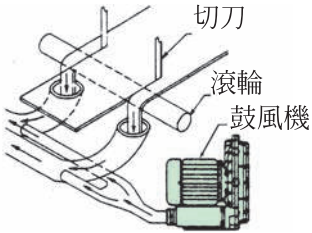
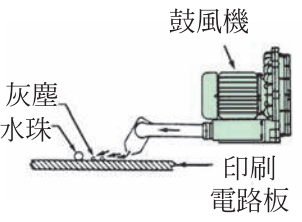
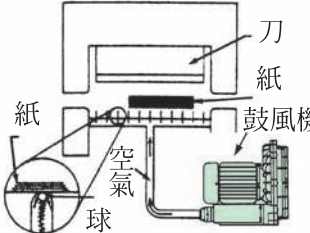
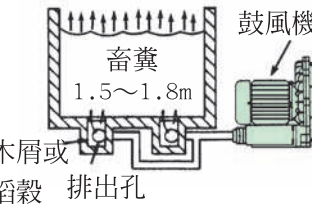
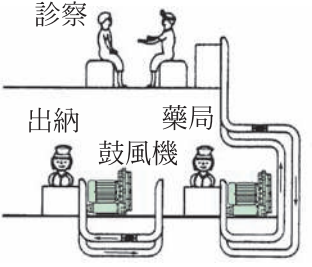
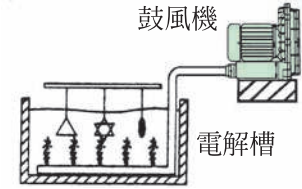
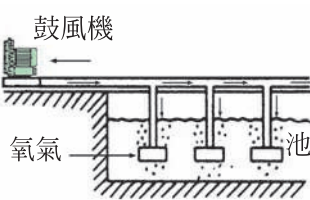
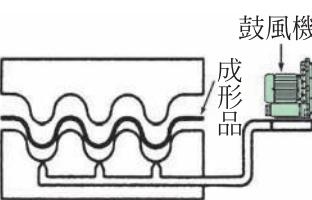
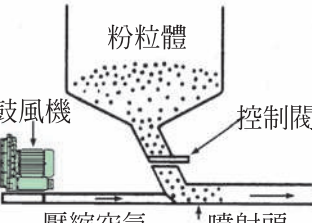
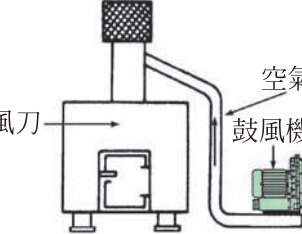
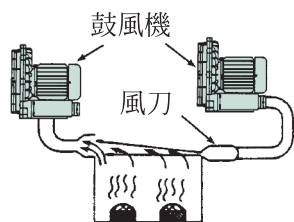
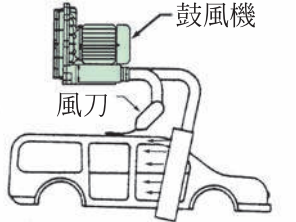
應用例 送風用 Applications Drawing

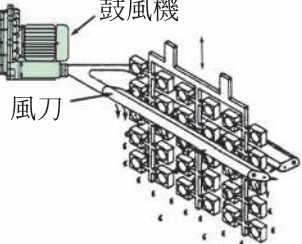
<p><b>瓦斯重油噴燃</b> Fuel Injection</p>  <p>高風壓 (2,000mmAq) 及足夠的風量，將減輕您對空氣壓縮機的依賴。</p>	<p><b>洗瓶機吹乾</b> Bottle Washing Machine</p>  <p>飲料空瓶水洗後將水滴吹乾，適用於食品業。</p>	<p><b>紙布條吹送</b> Ribbon Collecting</p>  <p>塑膠、布、紙等裁邊後廢屑自動收集。</p>	<p><b>乾燥用空氣刀</b> Cleaning Nozzle</p>  <p>電子業電路基板可利用送風機來吹除微小灰塵及水滴。</p>
<p><b>裁斷機氣墊</b> Cutting Air-Pad</p>  <p>增加浮力，容易移動。</p>	<p><b>畜糞發酵曝氣</b> Feeding Air</p>  <p>以高壓空氣吹入畜糞槽，增加畜糞與空氣接觸面積。亦適於公害污水處理。</p>	<p><b>傳票輸送</b> Documents Conveying</p>  <p>以空氣為動力輸送文件既快速又確實。</p>	<p><b>電解液攪拌</b> Electrolysis Mixer</p>  <p>利用空氣來攪動電解槽，使電解質流通，並把附著水泡驅開令電鍍迅速，效果均勻。(出口孔以4mm最佳)</p>
<p><b>養殖池的氧氣補給</b> Breeding Pool</p>  <p>水中之氧氣補給用。</p>	<p><b>沖床機</b> Presses Machine</p>  <p>便利取出沖壓後之成形品。</p>	<p><b>粉粒體輸送</b> Powder&amp;Granule Conveying</p>  <p>粉體粒體等之原料的空氣運送。</p>	<p><b>焚化爐</b> An Incinerator</p>  <p>空氣的助燃與廢氣之排出。</p>
<p><b>煙氣吹吸</b> Smog Inhale or Blow</p>  <p>讓散出之煙氣迅速排出，以免造成污染。</p>	<p><b>洗車吹乾</b> Car Washing</p>  <p>洗車機洗後之水份吹乾。</p>	<p><b>印刷強制乾燥</b> Printed Dryer</p>  <p>使印色快速乾燥。</p>	<p><b>洗淨後吹乾</b> Blow the Universe After Clean</p>  <p>洗淨後之水份或油氣迅速脫離物品。</p>

送風 ● 吸塵 ● 排氣 ● 冷卻 ● 輸送 ● 氣墊

應用例 吸風用 Applications Drawing

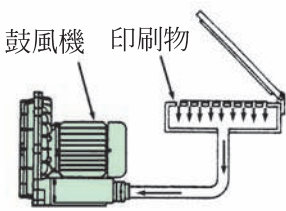
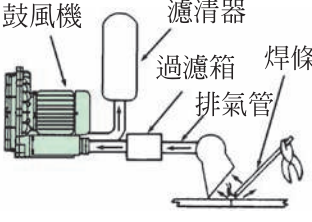
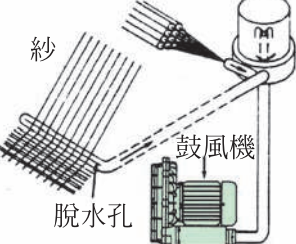
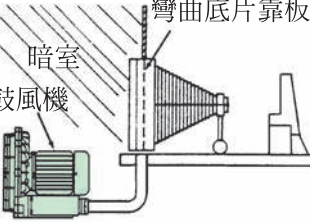
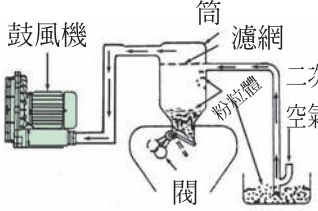
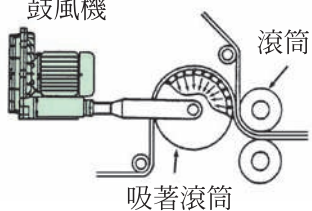
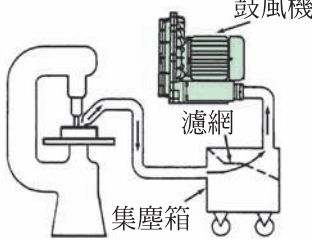
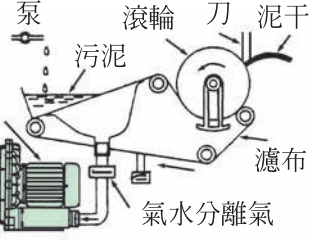
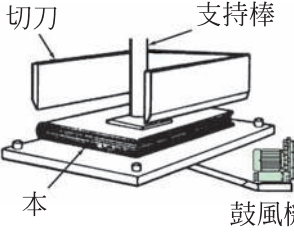
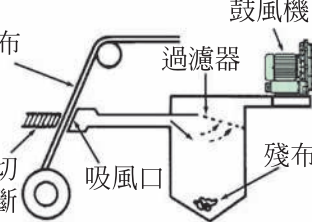
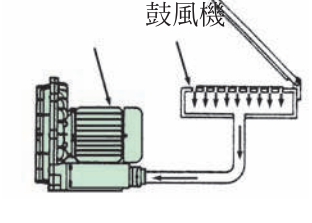
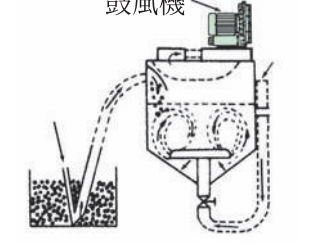
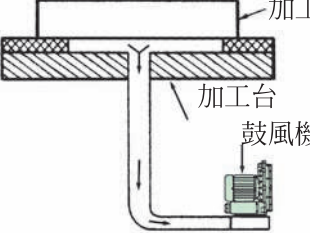
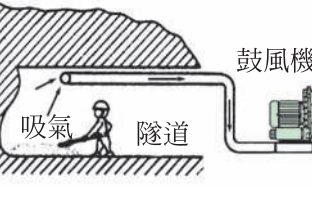
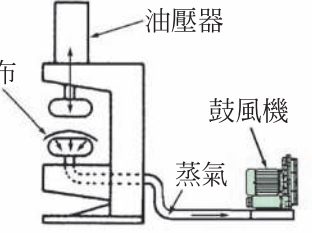
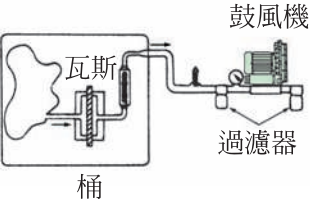
<p><b>網版印刷機吸著</b> Printing Suck</p>  <p>利用吸著壓力固定，以利印刷作業。</p>	<p><b>焊接廢氣吸取</b> Welding Smog Collecting</p>  <p>焊接時產生之煙氣和塵埃，可以真空方式排到他處，保障操作員健康。</p>	<p><b>織布機吸絲</b> Textile Machinery Suck</p>  <p>吸除水分及固定線頭，提高產品的品質及效率。</p>	<p><b>照相製版</b> Photograph</p>  <p>利用真空吸力來保持底片，使之平坦，適合照相製版工業。</p>
<p><b>粉粒體輸送</b> Raw Material Conveying</p>  <p>粒狀物體，如塑膠原料等，可利用氣壓（吹）或真空吸力來完成輸送任務。</p>	<p><b>印刷吸著</b> Printing Stabilizing</p>  <p>真空吸著印刷或紙巾成形移送。</p>	<p><b>工業吸塵</b> Duct Collecting</p>  <p>工廠中經常有廢屑殘留機台上，可以上圖方式清潔之。</p>	<p><b>真空脫水</b> Vacuum Dehydration</p>  <p>紙漿脫水，污泥脫水，布匹脫水等。</p>
<p><b>製書本機</b> Book Packager</p>  <p>切斷時之書本吸著保持。</p>	<p><b>殘布處理</b> Wasted Ribbon Collecting</p>  <p>布匹切斷之處理。</p>	<p><b>牛乳紙盒充填機</b> Milk Box Feeding</p>  <p>牛乳盒充填之真空吸引利用。</p>	<p><b>豆腐機械</b> Soybean Curd Machine</p>  <p>吸引大豆輸送，至洗淨槽洗淨使用。</p>
<p><b>加工物的保持</b> Processing Stabilizing</p>  <p>木板、塑膠等非磁性物體之固定用。</p>	<p><b>工事現場</b> Smog Sucking inner Tunnel</p>  <p>隧道與狹小工事現場產生粉塵有毒瓦斯之局部除去。</p>	<p><b>燙布機</b> Ironing Machine</p>  <p>燙布時將其蒸氣吸出排放用。</p>	<p><b>瓦斯分解</b> Gas Decomposing</p>  <p>使用於瓦斯分解裝置的吸引。</p>



## 環形鼓風機 Ring Blower (Side Channel Blower)

用途：應用再生理論所設計的環形鼓風機，單段風葉經小風量增速，產生高風壓特性。

---- 免保養！無油氣！壽命長！

**Futural:** Ring Blowers are designed with practical regenerative theory

Require no maintenance ! No oily odor ! eternity life!

**at 60HZ**

型 式 Type	相 數 Phase	功 率 Power (KW)	電 壓 Voltage (V)	電 流 Current (A)	最大使用靜壓 吸入/吐出 Vacuum/Pressure (Rated) (kpa)	最大風量 (吐出) Air Flow (max) (m <sup>3</sup> /min)	出 入 口 徑 In/Out Let	噪 音 Noise Level (dB)	重 量 Weight (Kg)
RB-200S	1~	0.2	220	1.5	7/9	0.6	PF 1"	65	8
RB-400S	1~	0.4	220	2.5	10/12	1.3	PF 1 1/4"	68	11
RB-750S	1~	0.75	220	5	14/15	2.5	PF 1 1/2"	72	16
RB-022S	1~	1.5	220	9	14/15	4.5	PF 2"	75	26
RB-200	3~	0.2	220	1.1	7/9	0.6	PF 1"	65	7.5
RB-400	3~	0.4	220	1.9	10/12	1.3	PF 1 1/4"	68	10
RB-750	3~	0.75	220	3	14/15	2.5	PF 1 1/2"	72	15
RB-750-2	3~	1.5	220	5.5	25/28	2.5	PF 1 1/2"	72	19
RB-022	3~	1.5	220	5.5	14/15	4.5	PF 2"	75	23
RB-023	3~	2.2	220	8	21/25	4.5	PF 2"	75	26
RB-033	3~	2.2	220	8	15/15	6	PF 2"	78	28
RB-035	3~	3.7	220	13	28/30	6	PF 2"	78	36
RB-055	3~	3.7	220	13	22/21	7.5	PF 2"	85	42
RB-057	3~	5.5	220	19	30/34	7.5	PF 2"	85	52
RB-077	3~	5.5	220	19	28/25	11	PF 2 1/2"	95	57
RB-0710	3~	7.5	220	26	30/38	11	PF 2 1/2"	95	67
RB-110N	3~	7.5	220	26	26/24	12	PF 2 1/2"	85	68
RB-1515	3~	11	220	35	15/15	24	PF 4"	105	120
RB-1520	3~	15	220	47	20/20	24	PF 4"	105	130
RB-1525	3~	19	220	58	25/25	24	PF 4"	105	140

附註：由於技術上的需要本公司保留設計與變更的權利。

A policy of continuous improvement is followed, and the right to alter any published data without notice is reserved.

允許最大氣溫和氣體進口溫度為40°C。

the maximent permissible temperature and the gas temperature at the inlet is 40°C.

連接變頻器使用時,請在40~60Hz範圍使用。

When connected to the inverter, please use in the range of 40~60Hz.

# 環形鼓風機 Ring Blower (Side Channel Blower)

## RB型性能表 Characteristic curves

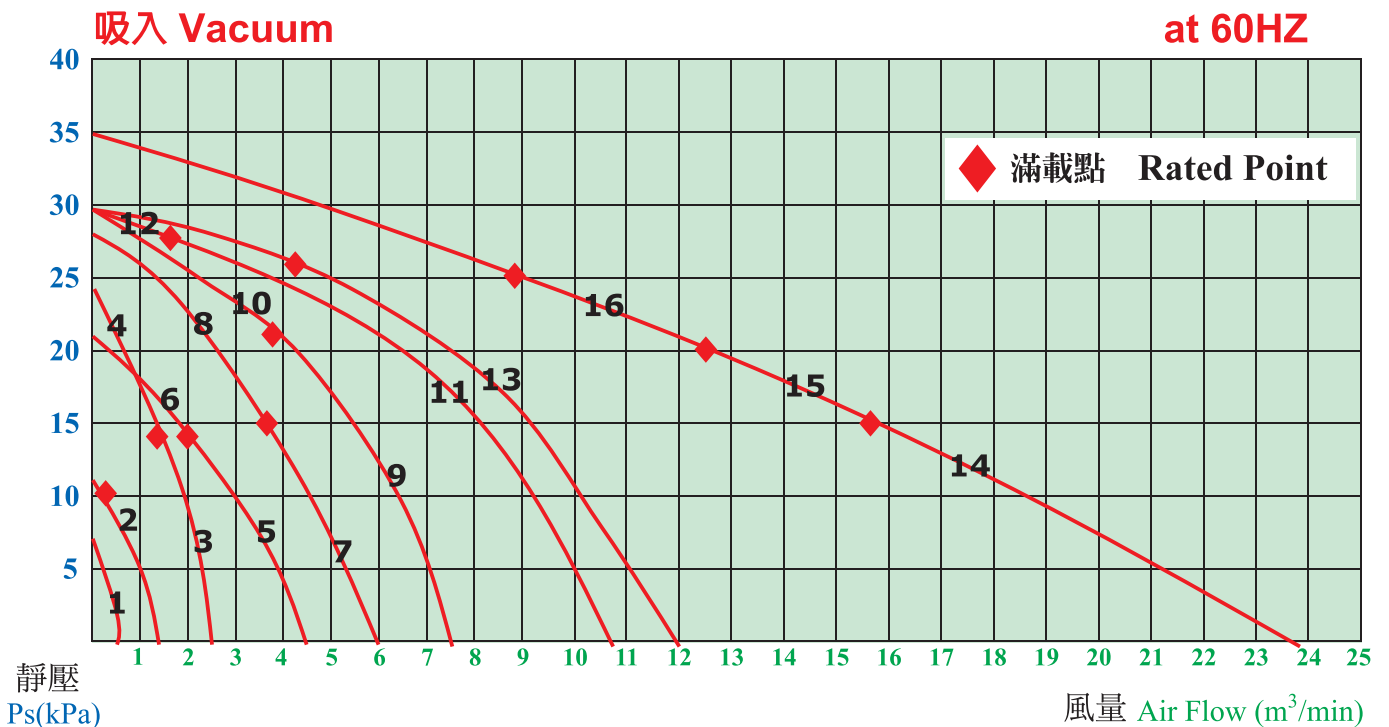
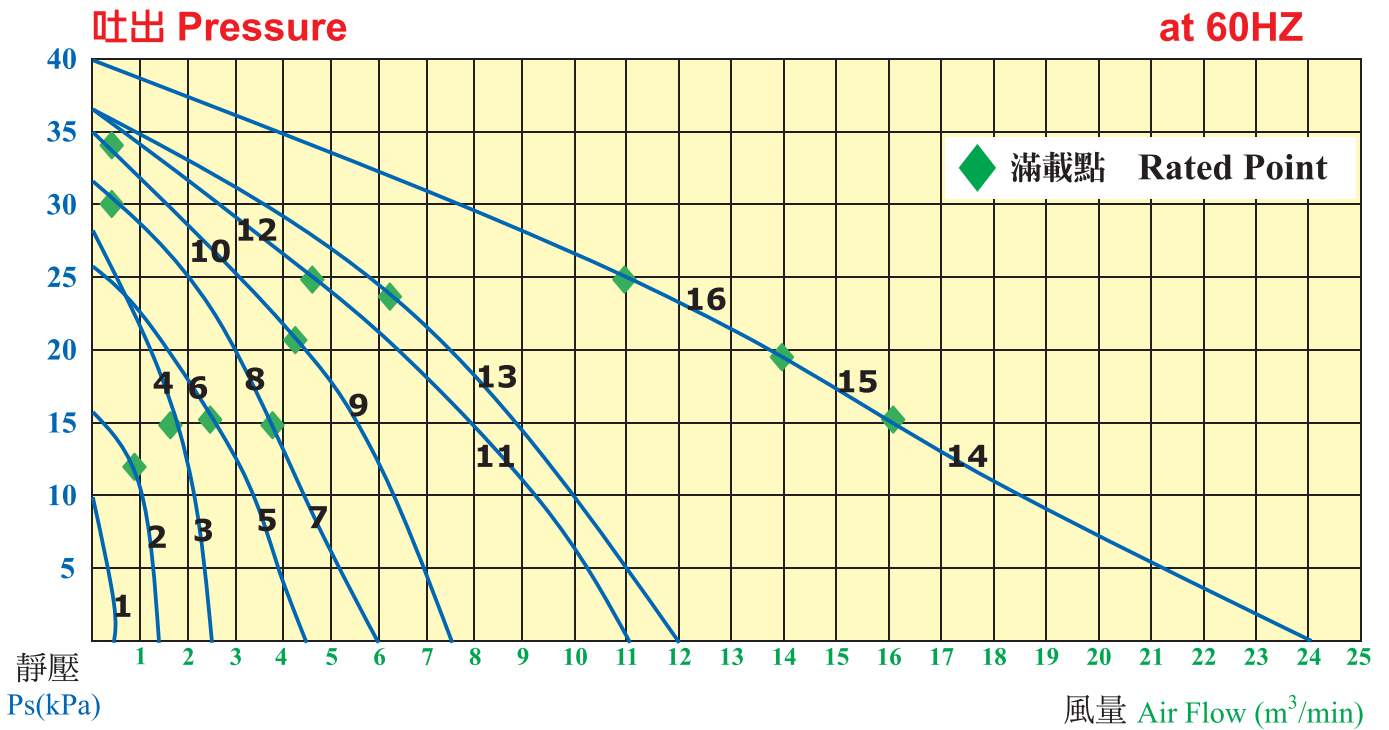

1	RB-200	2	RB-400	3	RB-750	4	RB-750-2	5	RB-022
6	RB-023	7	RB-033	8	RB-035	9	RB-055	10	RB-057
11	RB-077	12	RB-0710	13	RB-110N	14	RB-1515	15	RB-1520
16	RB-1525								

## 環形鼓風機 Ring Blower (Side Channel Blower)

用途：應用再生理論所設計的環形鼓風機，單段風葉經小風量增速，產生高風壓特性。

---- 免保養！無油氣！壽命長！

**Futural:** Ring Blowers are designed with practical regenerative theory

Require no maintenance ! No oily odor ! eternity life!

**at 50HZ**

型 式 Type	相 數 Phase	功 率 Power (KW)	電 壓 Voltage (V)	電 流 Current (A)	最大使用靜壓 吸入/吐出 Vacuum/Pressure (Rated) (kpa)	最大風量 (吐出) Air Flow (max) (m <sup>3</sup> /min)	出 入 口 徑 In/Out Let	噪 音 Noise Level (dB)	重 量 Weight (Kg)
RB-200S	1~	0.2	220	1.5	6/7	0.6	PF 1"	65	8
RB-400S	1~	0.4	220	2.5	9/10	1.3	PF 1 1/4"	65	11
RB-750S	1~	0.75	220	5	13/16	2	PF 1 1/2"	67	16
RB-022S	1~	1.5	220	9	17/18	3.2	PF 2"	70	26
RB-200	3~	0.2	380	0.9	6/7	0.6	PF 1"	60	7.5
RB-400	3~	0.4	380	1.3	9/10	1.3	PF 1 1/4"	65	10
RB-750	3~	0.75	380	1.8	13/16	2	PF 1 1/2"	67	15
RB-750-2	3~	1.5	380	3.5	20/22	2	PF 1 1/2"	67	19
RB-022	3~	1.5	380	3.5	17/18	3.2	PF 2"	70	23
RB-023	3~	2.2	380	5	18/21	3.2	PF 2"	70	26
RB-033	3~	2.2	380	5	20/20	5	PF 2"	75	28
RB-035	3~	3.7	380	7.5	22/29	5	PF 2"	75	36
RB-055	3~	3.7	380	7.5	22/24	7	PF 2"	85	42
RB-057	3~	5.5	380	11.5	26/30	7	PF 2"	85	52
RB-077	3~	5.5	380	11.5	22/30	9	PF 2 1/2"	88	57
RB-0710	3~	7.5	380	15.5	23/30	9	PF 2 1/2"	88	67
RB-110N	3~	7.5	380	15.5	23/28	10	PF 2 1/2"	85	68
RB-1515	3~	11	380	21	20/18	19	PF 4"	95	120
RB-1520	3~	15	380	28	26/24	19	PF 4"	95	130
RB-1525	3~	19	380	35	32/30	19	PF 4"	95	140

附註：由於技術上的需要本公司保留設計與變更的權利。

A policy of continuous improvement is followed, and the right to alter any published data without notice is reserved.

允許最大氣溫和氣體進口溫度為40°C。

he maximent permissible temperature and the gas temperature at the inlet is 40°C.

連接變頻器使用時,請在40~60Hz範圍使用。

When connected to the inverter, please use in the range of 40~60Hz.



# 環形鼓風機 Ring Blower (Side Channel Blower)

## RB型性能表 Characteristic curves

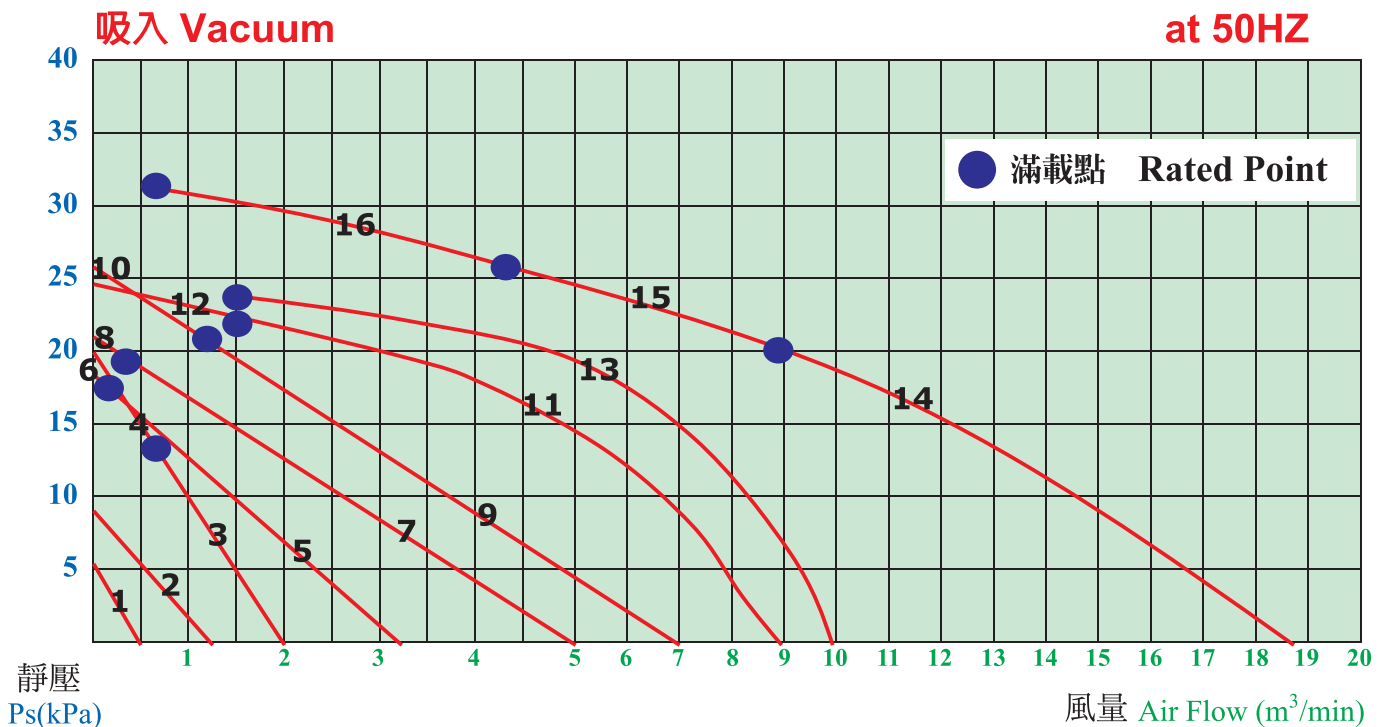
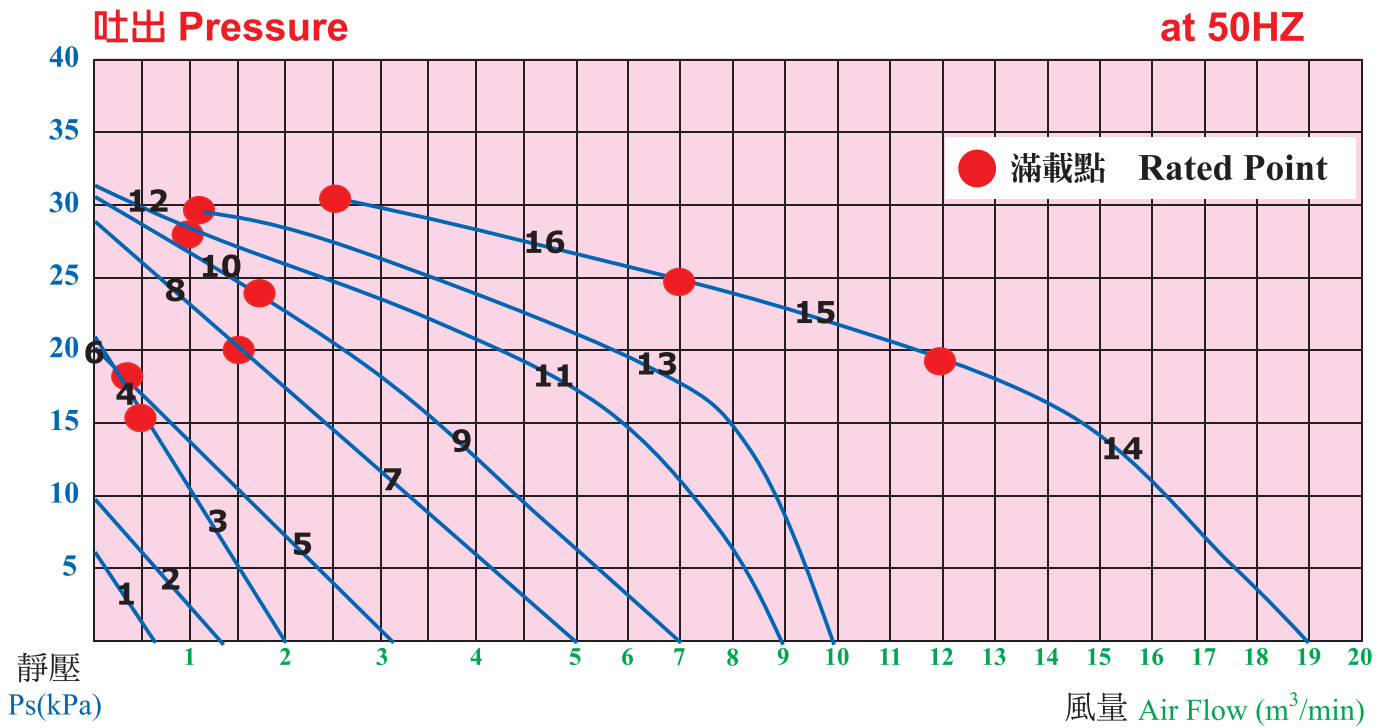

1	RB-200	2	RB-400	3	RB-750	4	RB-750-2	5	RB-022
6	RB-023	7	RB-033	8	RB-035	9	RB-055	10	RB-057
11	RB-077	12	RB-0710	13	RB-110N	14	RB-1515	15	RB-1520
16	RB-1525								

# 環形鼓風機 Ring Blower (Side Channel Blower)

尺寸圖 Dimension (mm)

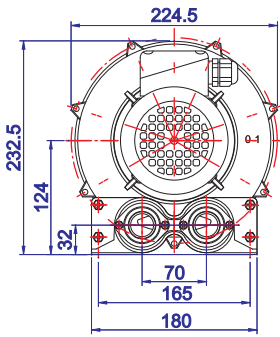

**RB-200**

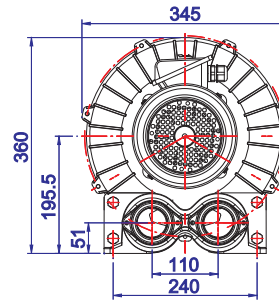
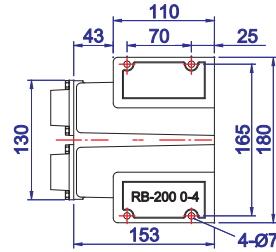
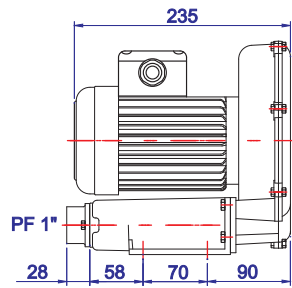

**RB-022**

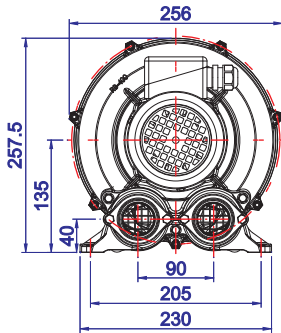
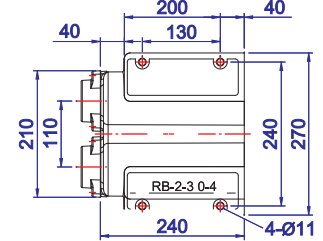
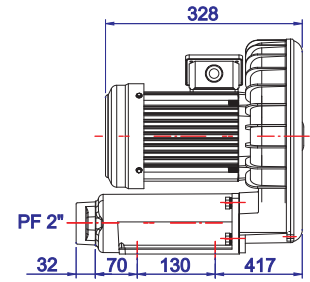

**RB-400**

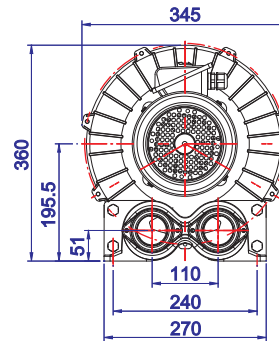
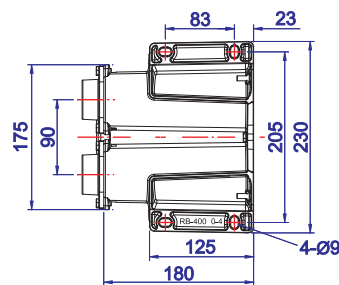
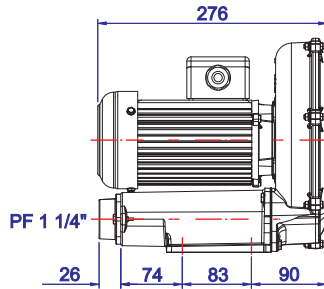

**RB-023**

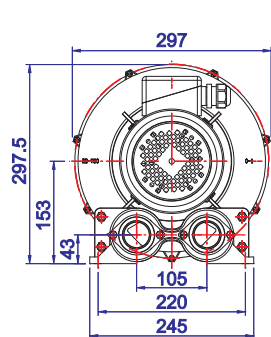
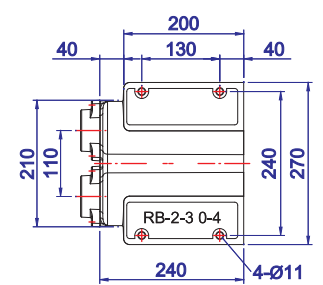
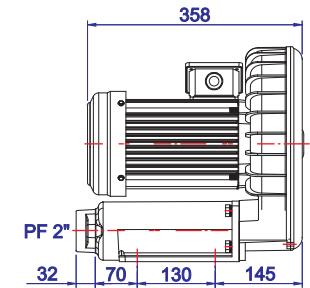

**RB-750 (RB-750-2)**

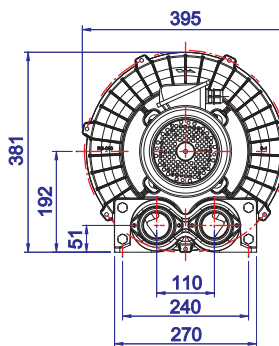
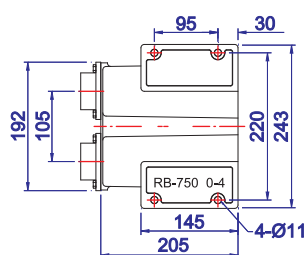
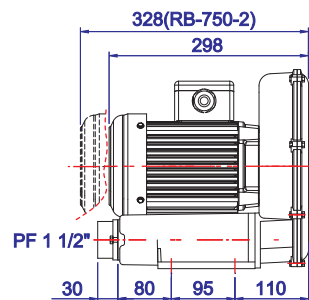

**RB-033**

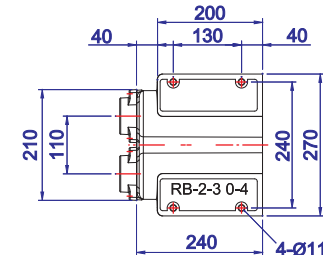
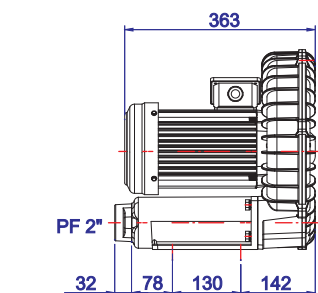

# 環形鼓風機 Ring Blower (Side Channel Blower)

尺寸圖 Dimension (mm)

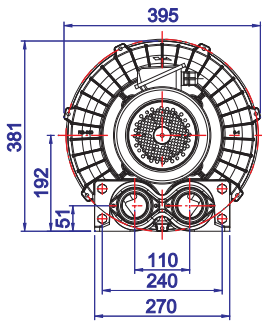

**RB-035**

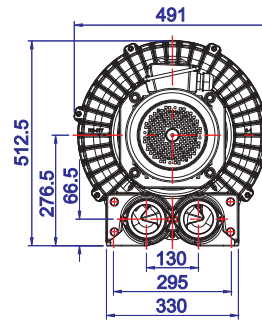
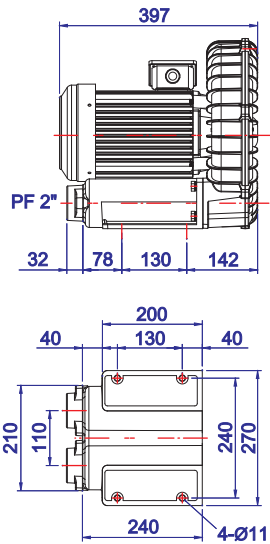

**RB-077(RB-0710)**

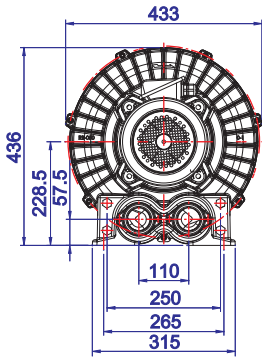
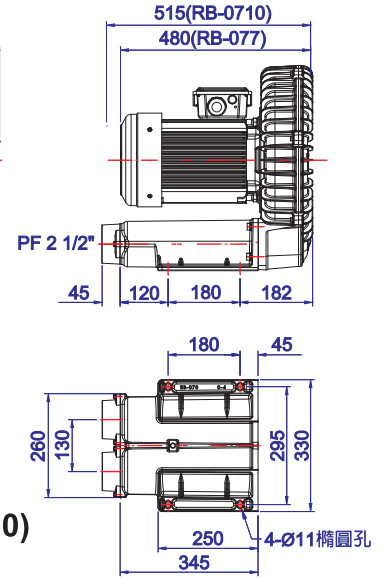

**RB-055**

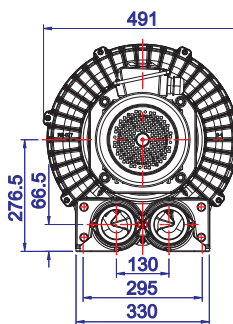
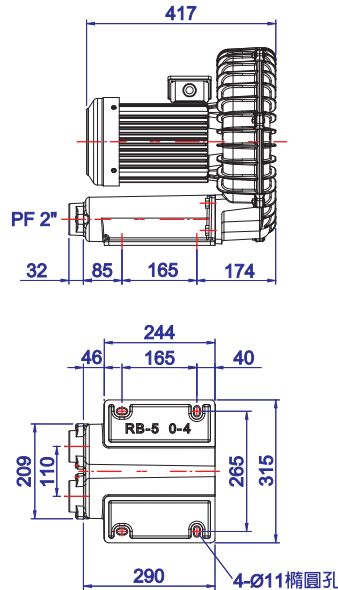

**RB-110N**

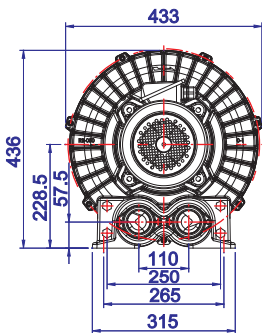
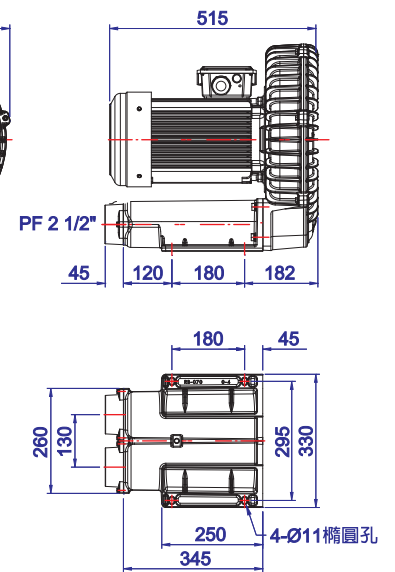

**RB-057**

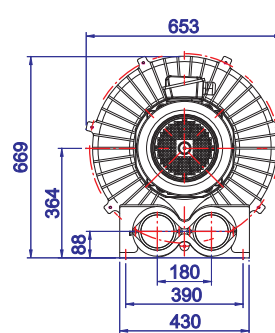
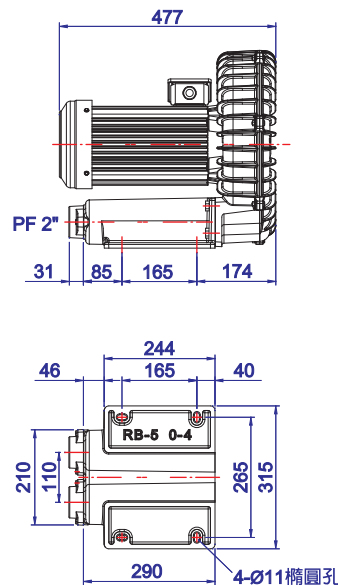

**RB-1515  
RB-1520  
RB-1525**

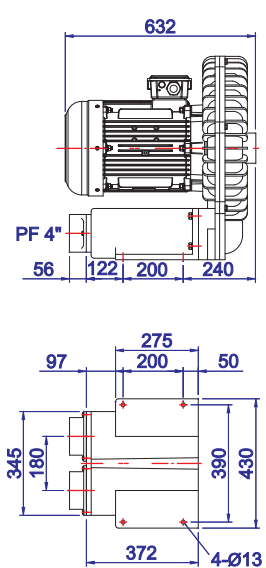



## 附加配件 APPURTENANCES

### 過濾器 Air Filter

過濾器是用於RB型風機的入口處，當風機只用吹氣時，請加裝本裝置以確保風機之安全。

此過濾器為圓筒型不鏽鋼網組成，通氣度高，不影響風機的流量，且裝卸容易、易清洗、免保養。

#### AIR FILTER

- Air filter is the inlet model and provides for all RB series applications.
- All air filters are cylindraceous and made by stainless net steel.
- Increase ventilation without act on blowers operation.
- All air filters can be safely cleaned and no maintenance required.
- For increase blowers service life, air filter is recommended to append.

型式編號 Model	口徑 PT	外徑 D mm	總長度 H mm	濾網長度 H <sub>1</sub> mm	六角對邊 B mm	重量 Weight kg	濾網精度 Filtration Mesh
MF-08-P	1"	70	187	175	50	0.2	100
MF-10-P	1 ¼"	70	187	175	50	0.2	100
MF-12-P	1 ½"	100	225	205	69	0.5	150
MF-16-P	2"	100	225	205	72	0.5	150
MF-20-P	2 ½"	130	270	245	90	0.7	150
MF-24	3"	159	353	326	105	1.18	100
MF-32	4"	208	353	338	147	2.95	100

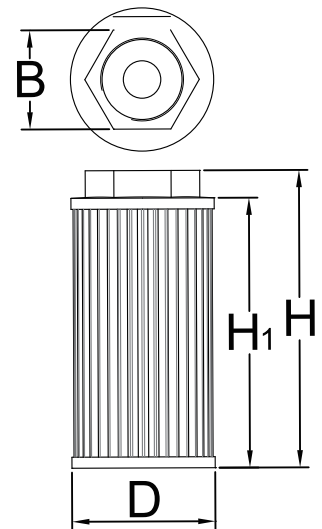

### 外用消音器 Silencer

外用消音器是一種消音效果非常好的裝置，當環境因素需要更低的噪音時，請多加利用。

此裝置可用於風機的出入口端或管線的末端，使用上非常方便。

#### SILENCER

- Good performance of noise reduction.
- Suitable for application at inlet, outlet and circuit end.

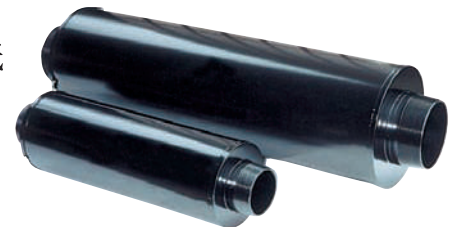

型式	口徑	適用機種
SI-2	2"	RB-750 • RB-022 • RB-033 • RB-055
SI-3	3"	RB-077 • RB-0710 • RB-110

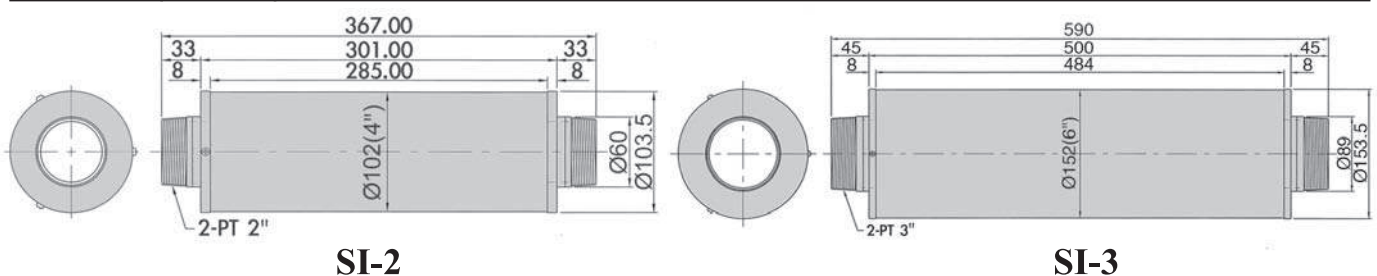

# 鋁合金高效率均壓風刀

## ALUMINUM AIR KNIFE

**產品特點：**本風刀是由全風公司所研發，以鋁合金擠壓一體成型，雨滴型整流結構，風壓風量均勻，壓損低，構造單純，材質堅固，組裝容易。可調式出風口設計，出風口的氣流是單方向吹出設計，滿足多元化生產需要。

**Features :** The air knife is a research and development by Chuan Fan company. The extruded aluminum, raindrops rectifier structure, uniform air flow pressure, low pressure drop, simple structure, strong material, easy to assemble. Adjustable outlet design, the outlet air flow is blown in one direction designed to meet the diverse production needs.

**應用：**吹除工件表面的水份或油份、冷卻降溫、熱風吹乾等....。

**Application :** Blowing the surface of the water or oil, cooling , hot air drying, etc

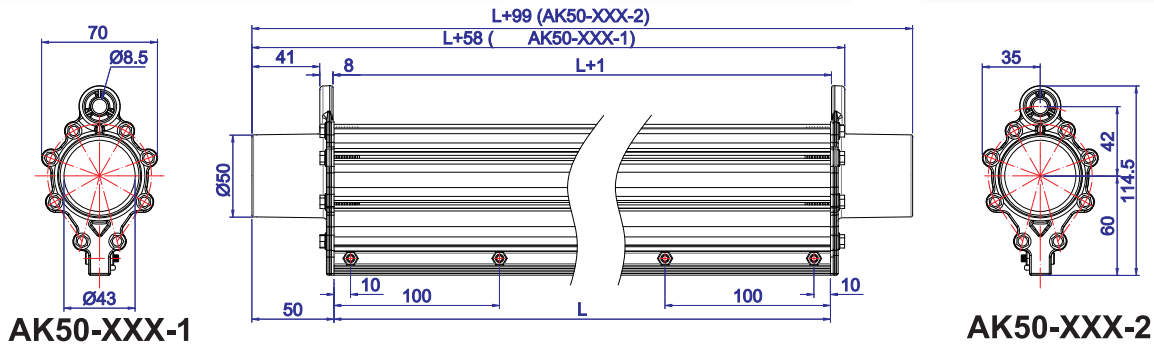
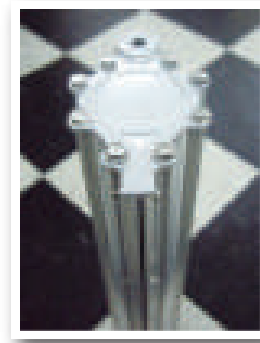

### 型號選擇 Model selection

AK○○○-XXX-X/X

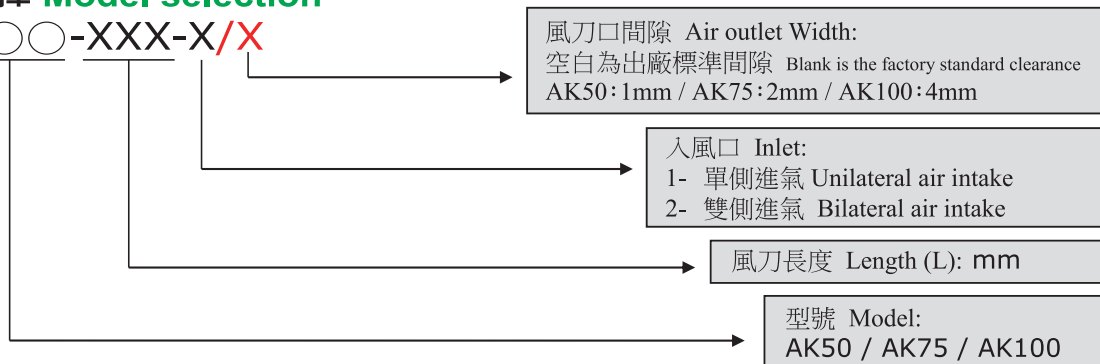

### 適用鼓風機概算 Estimates for Blowers

所需風量(m<sup>3</sup>/min)=[風刀長度(m)x出風口寬度(m)]x希望風速(m/sec)x60x(1.2~1.5)

Airflow(m<sup>3</sup>/min)= [Length (m) x Air outlet width (m)] x Wind speed (m/sec) x 60 x (1.2~1.5)

所需靜壓 (kPa)

風刀出口寬度 Air outlet width	1mm	2mm	3mm	4mm	5mm
所需靜壓 Static pressure	10kPa以上 10kPa or more	5~15kPa	3~8kPa	2~5kPa	1~3kPa

P.S. 上述資料須在(使用點)上計算

P.S. The above information is required (point of use) is calculated on



中國能效



UL/CAN

IE3 Motor

CE

CCC

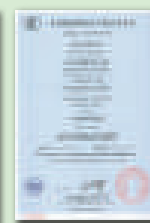
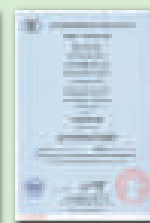
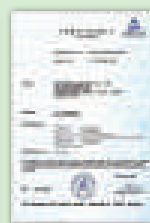
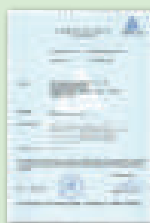
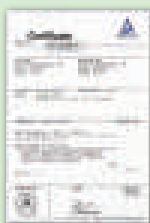
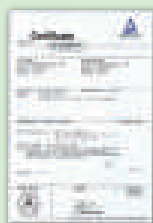

批發 • 製造 • 買賣 manufacturer, distributor



**CHUAN-FAN ELECTRIC CO., LTD.**

營運部/楊梅廠：  
桃園市楊梅區(幼獅工業區)青年路6-2號(幼獅交流道南下旁)  
No.6-2 Qingnian Rd, Youth Industrial Park, Yangmei Dist,  
Taoyuan City 32661, Taiwan

Tel:886-3-4643788 Fax:886-3-4643771

銅鑼廠：苗栗縣銅鑼鄉銅鑼工業區自強路23號  
Tel:037-980-722 Fax:037-980-725

